



### HMPC Key Features

#### Isolation Transformer Option:

- Proven Harmony™ or Ulltra™ High Efficiency Transformer reliability
- High transformer efficiencies maintained over a wide load range, not just at light load levels
- Harmonic Mitigating Transformer (HMT) options include patented Harmony-2E which treats all four major current harmonics (3rd, 5th, 7th & 9th) by flux cancellation within secondary windings
- All HMT transformers prevent triplens from circulating in the primary windings
- Dual electrostatic shield for noise suppression
- Harmonic losses lowered both within transformer and in upstream distribution

#### Autotransformer Option:

- Unique and patent pending autotransformer configuration provides significant energy savings in 415V Data Center applications. Allows for the use of standard 480V UPS systems
- Only autotransformer suitable for 3-wire In / 4-wire Out but requires local electrical authority approval. No special approval required for 4-wire In / 4-wire Out applications.
- Built-in harmonic mitigation treats all four major harmonics (3rd, 5th, 7th & 9th)
- Smaller footprint and significantly lower losses than isolation transformers

### HMRP Key Features

- Built-in harmonic mitigation treats all four major harmonics (3rd, 5th, 7th & 9th)
- Eliminates need for double neutrals and reduces neutral-to-ground voltage
- Lowers operating costs by reducing losses and eliminating the need for K-rated transformers
- Diverts up to 90% of the neutral current leaving the panelboards
- Reduces harmonic induced ground currents

### General Features

- Meets IEEE Standard 519 harmonic limits
- Genuine 100% non-linear load compatibility
- Improves power quality by minimizing voltage flat-topping
- Reduces input current distortion
- Improves connected equipment reliability by lowering internal I<sup>2</sup>R losses and restoring power interruption ride-through capability
- Frees up UPS or upstream distribution capacity by improving power factor and phase current balance
- Available comprehensive Monitoring and Alarms with Remote Communications
- Optional TVSS protects the loads against damage caused by transient voltages

## Taking the HARM out of HARMONICS!

### Harmonic Mitigating Power Center (HMPC)

The Data Center environment is packed with harmonic generating power electronic equipment. To ensure electromagnetic compatibility with these non-linear loads, the power distribution system must be equipped with transformers that treat harmonics, rather than just tolerate them.

At the heart of the ONICS™ HMPC is MIRUS' proven high efficiency and harmonic mitigating transformer (HMT) technology. The unique secondary winding configuration of the Harmony-2E™ minimizes output voltage distortion and flat-topping by cancelling 3rd, 5th, 7th and 9th harmonic fluxes, preventing these harmonic currents from appearing in the primary winding. Consequently, voltage distortion will be within IEEE Std 519 limits despite the application of substantial harmonic loads.

The new ULLTRA™ ultra high efficiency transformer option meets NEMA Premium (CSL-3) efficiency levels not only at light loads, but over a much wider load range, ensuring energy savings in your 'Green' Data Center regardless of loading. Another trend in 'Green' Data Center design is to use 415/240V distribution. MIRUS offers a unique and patent pending autotransformer configuration for voltage transformation from 480 - 415/240V. This allows for standard 480V distribution to the HMPC. The Harmonic Filter and autotransformer are combined into one magnetic package to save space and significantly reduce losses.

The HMPC integrates harmonic mitigation with noise suppression, electronic grade grounding, non-linear load distribution panels, TVSS, monitoring and alarms for a complete power quality package.

### Harmonic Mitigating Remote Panelboards (HMRP)

The ONICS™ Harmonic Mitigating Remote Panelboard (HMRP) integrates MIRUS' patented and proven harmonic mitigating technology with two 42-circuit or 30-circuit distribution panelboards, optional monitoring and TVSS in an attractive, easy to install package. ONICS™ treats all four of the major current harmonics created by single-phase, switch-mode power supplies (SMPS) by diverting the triplen (3rd and 9th) harmonics from the neutral and by canceling the 5th and 7th harmonics through phase-shifting. Overheating of distribution transformers and their neutral conductors is no longer a problem. Voltage distortion is kept well within IEEE Std 519 limits thereby increasing the reliability of the connected equipment. Operating costs are reduced because harmonic induced losses in the power distribution system are lowered by the ONICS™ HMRP.

# ONICS Model Numbers

**HMxx - ppp - vv - size - xfmr dd**

**Onics Series**  
 HMPC = Power Center  
 HMRP = Remote Panelboard

**Pole Positions**  
 000 = No Panelboards  
 084 = 2 Panelboards, 84 poles<sup>a</sup>  
 126 = 3 Panelboards, 126 poles<sup>b</sup>  
 168 = 4 Panelboards, 168 poles  
 252 = 6 Panelboards, 252 poles  
a. Not available with Harmony-3 Transformer  
 b. Not available with Harmony-2 Transformer

**Input Voltage**<sup>c</sup>  
 HMPC: A = 208, B = 480, C = 600  
 HMRP: A = 120/208, B = 277/480

**Output Voltage**  
 A = 120/208, I = 240/415, H = 230/400

**Displacement Angle**<sup>c</sup>  
 00, 15, 20, 30  
c. Not applicable with HF3579 or HF00

**Transformer**  
 H1E, H2E, H3E, ULL, ULLH1E Transformer  
 HF3579 = 3<sup>rd</sup>, 5<sup>th</sup>, 7<sup>th</sup>, 9<sup>th</sup> Harmonic Filter  
 HF39 = 3<sup>rd</sup>, 9<sup>th</sup> Harmonic Filter  
 HF00 = No Filter

**KVA (HMPC)**  
 050 = 50kVA | 150 = 150kVA | 400 = 400kVA  
 075 = 75kVA | 200 = 200kVA | 500 = 500kVA  
 100 = 100kVA | 225 = 225kVA | 625 = 625kVA  
 125 = 125kVA | 300 = 300kVA | 750 = 750kVA

**AMPS (HMRP)**  
 100, 200, 225, 400, 600



## HMPC Rating Table

HMPC XFMR Size (kVA)	Input Rating Voltage (V) <sup>[1]</sup>	Current (A)	Input CB Size		Heat Rejection (BTU/Hr) <sup>[2]</sup>	84 Pole or Subfeed CB's		126 Pole				168 Pole				252 Pole			
			Frame (A)	Trip (A)		Encl. Type w/xfmr	Weight <sup>[3]</sup> lbs kg	Encl. Type w/xfmr	Weight (lbs) [kg]	Encl. Type w/xfmr	Weight (lbs) [kg]	Encl. Type w/xfmr	Weight (lbs) [kg]	Encl. Type w/xfmr	Weight (lbs) [kg]				
50	208	139	225	175	4400	A	A	1150	522										
	480	60	225	80	4400	A	A	1150	522										
	600	48	225	60	4400	A	A	1150	522										
75	208	208	400	250	6800	B	B	1320	599	B1	B1	1795	814	B1	B1	1820	825		
	480	90	225	125	6800	B	B	1320	599	B1	B1	1795	814	B1	B1	1820	825		
	600	72	225	100	6800	B	B	1320	599	B1	B1	1795	814	B1	B1	1820	825		
100	208	278	400	350	9100	B	B	1550	703	B1	B1	2025	918	B1	B1	2050	930		
	480	120	225	150	9100	B	B	1550	703	B1	B1	2025	918	B1	B1	2050	930		
	600	96	225	125	9100	B	B	1550	703	B1	B1	2025	918	B1	B1	2050	930		
125	208	347	600	450	10900	B	B	1600	726	B1	B1	2075	941	B1	B1	2100	952		
	480	150	225	200	10900	B	B	1600	726	B1	B1	2075	941	B1	B1	2100	952		
	600	120	225	150	10900	B	B	1600	726	B1	B1	2075	941	B1	B1	2100	952		
150	208	416	600	600	10900	B	B	1600	726	B1	B1	2075	941	B1	B1	2100	952		
	480	180	225	225	12800	B	B	1700	771	B1	B1	2175	986	B1	B1	2200	998		
	600	144	225	200	12800	B	B	1700	771	B1	B1	2175	986	B1	B1	2200	998		
200	480	241	400	300	17500	B	C	2100	952	B1	C1	2575	1168	B1	C1	2600	1179	B2	C2
	600	192	400	250	17500	B	C	2100	952	B1	C1	2575	1168	B1	C1	2600	1179	B2	C2
225	480	271	400	350	18400	B	C	2300	1043	B1	C1	2775	1259	B1	C1	2800	1270	B2	C2
	600	241	400	300	18400	B	C	2300	1043	B1	C1	2775	1259	B1	C1	2800	1270	B2	C2
300	480	361	450	450	19500	C	D	2700	1227	C1		3195	1449	C1		3220	1464	C2	
	600	289	400	400	19500	C	D	2700	1227	C1		3195	1449	C1		3220	1464	C2	
400	480	481	600	600	28600	D	D	3900	1769										
	600	385	600	500	28600	D	D	3900	1769										
500	480	602	800	800	35700	D	D	4600	2087										
	600	482	600	600	35700	D	D	4600	2087										
625	480	752	1200	1000	46300	D	D	5250	2381										
	600	601	800	800	46300	D	D	5250	2381										
750	480	902	1200	1200	55700	D	D	5600	2540										
	600	722	1200	1000	55700	D	D	5600	2540										

[1] Contact sales office for voltages & configurations not shown.  
 [2] Heat based on 100% resistive load; actual will increase only slightly with non-linear loading.  
 [3] Approximate values.  
 [4] HMPC ratings in this table are based on Harmony-1E Transformers. For other transformers consult the factory.

## HMPC Typical Schematics

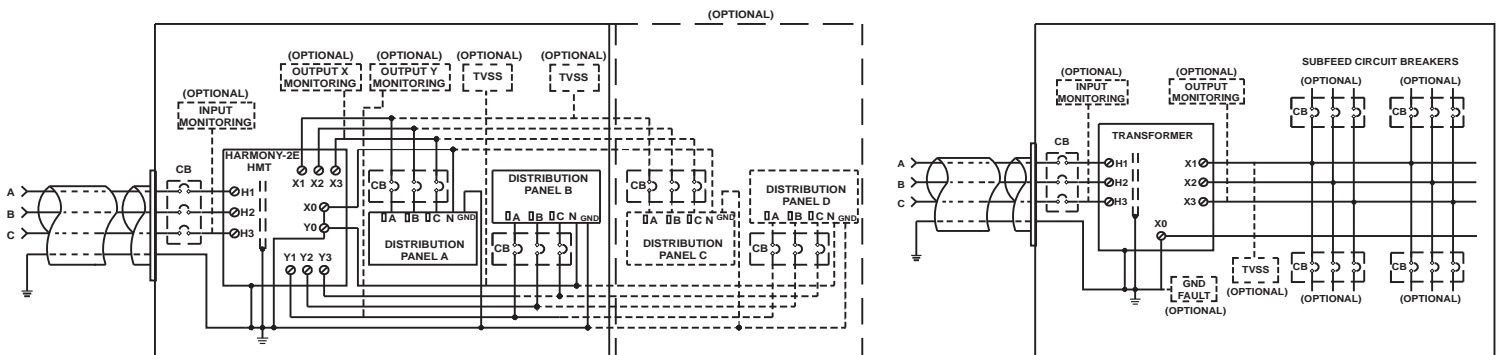

Notes:  
 A. Standard 2 Panel or optional 4 Panel configuration shown.  
 B. The Harmony-2E™ is an isolation transformer and is considered to be a separately derived source.

Notes:  
 C. Standard Subfeed Breaker configuration shown.

## HMPC Dimensions

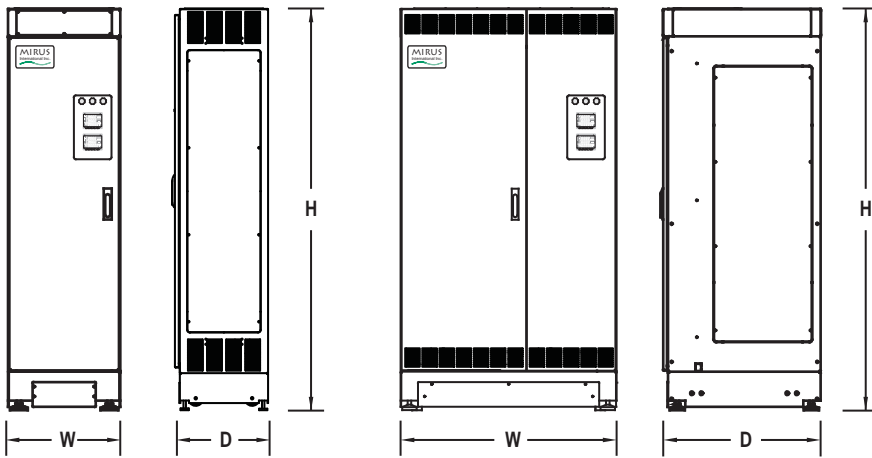

Type 'A' Enclosure

Type 'B' & 'C' Enclosure

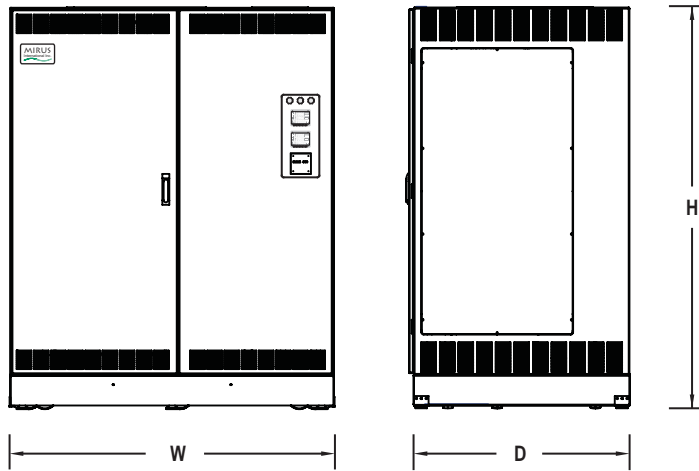

Type 'D' Enclosure

## HMPC Enclosure Dimensions

TYPE	42/84 Poles (W x D)	TYPE	126/168 Poles (W x D)	TYPE	252 Poles (W x D)	Height (H)
A	24 [610] x 24 [610]					75 [1905]
B	36 [914] x 32 [813]	B1	56 [1422] x 32 [813]	B1-1	76 [1930] x 32 [813]	78 [1981]
C	41 [1041] x 36 [914]	C1	61 [1549] x 36 [914]	C1-1	81 [2057] x 36 [914]	78 [1981]
D	66 [1676] x 45 [1143]	D1	86 [2184] x 45 [1143]	D1-1	106 [2692] x 45 [1143]	82 [2083]

1. Enclosure Dimensions are in ( inches [mm] ).
2. Standard configuration uses Sidecar Type-1 with front access.

## HMPC Enclosure Configurations

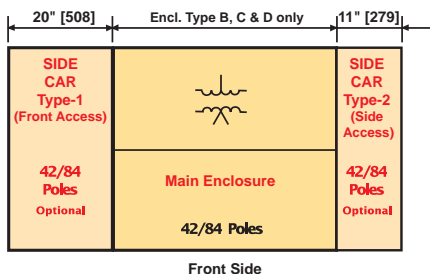

Notes:

1. Sidecar extension cabinet are optional and can be located on either side of main enclosure.
2. Type-1 Sidecar is front accessible with removable side panel.
3. Type-2 Sidecar requires side access.

## HMPC Technical Specifications:

### Input Rating

208, 480, 600VAC 60Hz  
3-Phase, 3 wire + Ground  
277/480VAC 60Hz  
3-Phase, 4-wire + Ground

### Output Rating

208/120VAC 60Hz  
3-Phase, 4-wire + Ground  
415/240VAC 60Hz  
3-Phase, 4-wire + Ground

### Efficiency

Nema TP1 Compliant and better

### Input Connection

To Input Main CB terminals

### Signal & Control Connections

To terminals, input conduit landing

### Grounding

Single point computer ground connection for zero sequence reference

### Ventilation

Convection cooled

### Alarms and Controls

EPO and Overtemperature standard  
(Other alarms available with opt. monitoring)  
Manual Restart

### Noise Isolation

Dual electrostatic shields

### Harmonic Mitigating Transformer

Low zero sequence impedance with phase shifted outputs to treat 3rd, 5th, 7th & 9th harmonics simultaneously

### Cable Access

Bottom for raised floor or top Access

### Enclosure

Type: Nema-1, ventilated  
Paint: Texture baked enamel Black  
Casters, levelers, removable swing-out dead front

## Options:

### Sub Feed Breakers

Sub feed CB  
Shunt Trip Relay

### Monitoring

Power Monitor, Advanced Power Monitor with Comm.  
Branch Circuit Monitoring  
Ground Fault Monitoring

### TVSS

40, 80, 120 kA / phase

### Ground Fault

Ground Fault Relay

## HMRP Technical Specifications:

### Input Rating

208, 480, 600VAC 60Hz  
3-Phase, 4 wire + Ground

### Output Rating

208/120VAC 60Hz  
415/240VAC 60Hz  
3-Phase, 4-wire + Ground

### Efficiency

Nema TP1 Compliant and better

### Input Connection

To Input Main CB terminals

### Signal & Control Connections

To terminals, input conduit landing

### Grounding

Single point computer ground connection for zero sequence reference

### Cable Access

Bottom for raised floor or top Access

### Harmonics Treated

3rd, 5th, 7th, 9th & others

### Output Distribution Panelboards

Square-D NQ, NF

### Ventilation

Convection air cooled

### Enclosure

Type: Nema-1, ventilated  
Paint: Texture baked enamel Black  
Casters, levelers, removable swing-out dead front

### Options:

#### Sub Feed Breakers

Sub feed CB in place of panelboards

#### Monitoring

Power Monitor, Advanced Power Monitor with Comm., Branch Circuit Monitoring

#### TVSS

40, 80, 120 kA / phase

## HMRP Dimensions

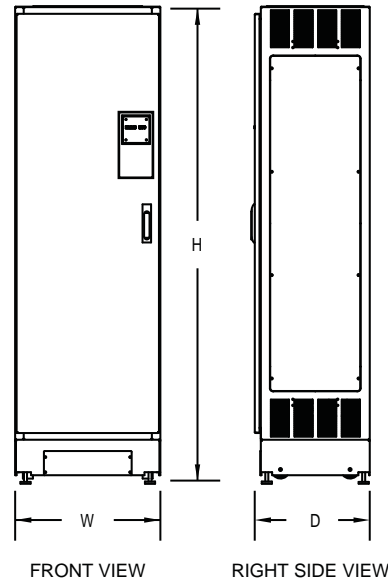

## HMRP Configuration

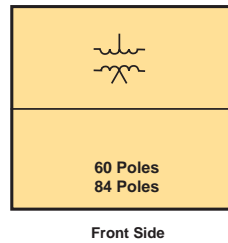

## HMRP Typical Schematic 120/208V

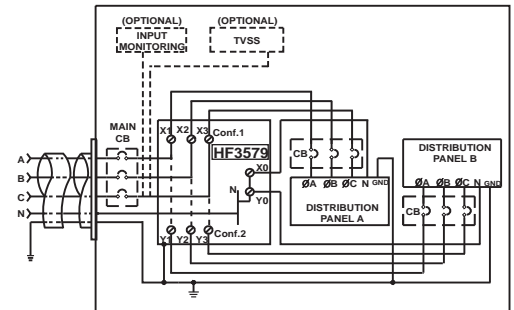

## HMRP Rating Table

HMRP SIZE (Model)	Voltage Input - Output (Volts)	Input Current (Amps)	Output Current (Amps)	Main Breaker (Amps)	Efficiency @50% Load (%)	Heat Dissipation (BTU/Hr)	Enclosure		Weight (lbs) [kg]	Panelboards (Poles)	
							Dimensions (H x W x D) (in)	Dimensions (H x W x D) [mm]			
100	277/480 - 240/415	100	116	125	> 99.2	< 4400	78 x 24 x 24	1981 x 610 x 610	600	272	2 x 30
200	277/480 - 240/415	200	231	250	> 99.2	< 8200	78 x 36 x 32	1981 x 915 x 813	1650	750	2 x 42
400	277/480 - 240/415	400	463	500	> 99.3	< 14300	78 x 36 x 32	1981 x 915 x 813	2500	1134	2 x 42
225	120/208	180	180	225	> 99.3	< 3800	78 x 24 x 19	1981 x 610 x 483	580	263	2 x 42
400	120/208	320	320	400	> 99.4	< 5100	78 x 24 x 24	1981 x 610 x 610	890	404	2 x 42
600	120/208	480	480	600	> 99.5	< 9000	80 x 36 x 32	2032 x 915 x 813	3000	1361	Subfeed CB

1. Heat based on 100% resistive load; actual will increase only slightly with non-linear loading.

© MIRUS International Inc. All specifications subject to change without notice.

## MIRUS International Inc.

31 Sun Pac Blvd., Brampton, ON, Canada L6S 5P6  
Tel: 905.494.1120 Fax: 905.494.1140  
Toll Free: 1-888 TO MIRUS (888.866.4787)  
www.mirusinternational.com

ONICS-PS01-A5  
Effective: December 2012